

FENCE PLANNER

for the COMMON SENSE FENCE™

Fencing technology in the U.S. has evolved from the first use of barbed wire in the late 1800's and woven wire soon after. This, along with steel and wood posts were the main means of animal control until electric fencing was introduced in the 1940's. Electric fencing was a wonderful invention in that it kept livestock both contained and away from the fence. Unfortunately, steel and wood posts continued to be used and insulators needed to be added. The cost of the insulator was always an important consideration and in an effort to keep insulators for farm fences affordable materials were chosen that typically had a short life span plus if dirt and moisture collected

on the surfaces, shorts occurred. Thus electric fencing was only used for temporary fencing. In another development in the 1970's, high-tensile wire was developed to get away from barbed wire. This wire needed to be installed close together and at high tension which required both extremely strong corners and line posts spaced close together, thus high cost. In the 1980's, the "COMMON SENSE FENCE" product line was introduced which combined the advantages of high tensile wire and electricity with "never to short out" Fiberglass Posts that could now be spaced at greater intervals. THIS IS THE PRODUCT WE ARE PRESENTING HERE.

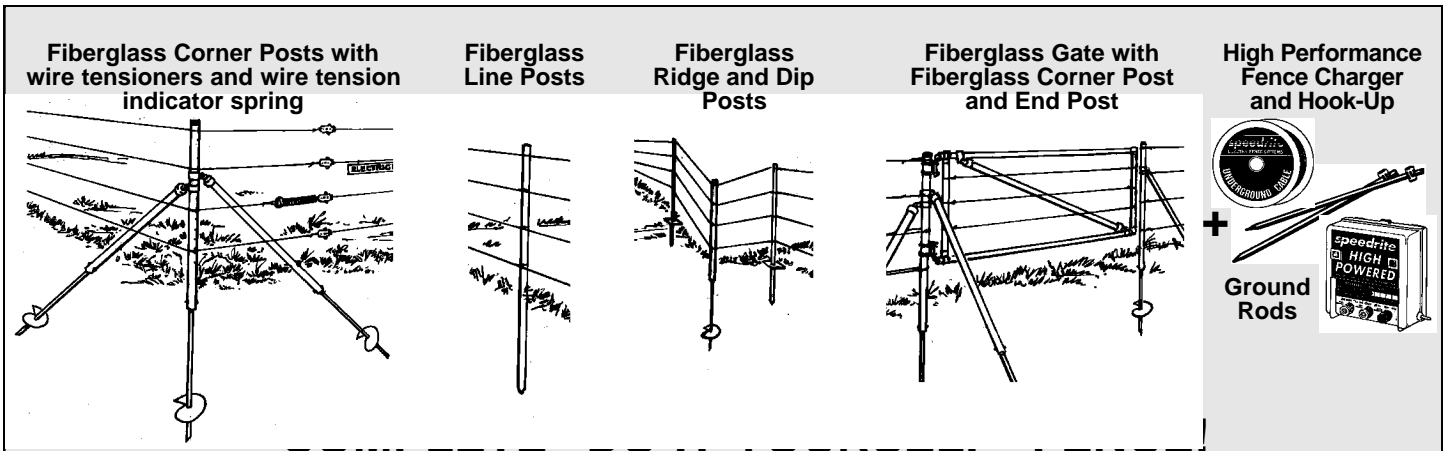

The easiest to install, safest, most dependable, longest lasting and most cost effective fence you can build, PERIOD!

TAKE TIME TO PLAN. The installation of any fencing system begins long before the first post is driven or wire is strung. The secret of getting the most from each dollar spent on fencing is to take the time to thoroughly plan, and then construct carefully. Any time that may be saved by incomplete planning, construction shortcuts or poor safety practices will only reduce the efficiency and life of the fence and will ultimately cost much more than is saved. NO ONE is better suited to plan the "Common Sense Fence" and construct it than the person who will use it...you. You know which animals are to be controlled and the lay of the land.

CHECK LOCAL LAWS AND ORDINANCES. Laws governing placement of fences and electric fencing vary from county to county. It is important to understand what your local ordinances have to say about electric fencing BEFORE you start. Questions such as: "How far must a fence be from a roadway?", "Can electric

fencing be used in suburban areas?" and "Are warning signs required?" must be answered. If in a rural area, check with your County Extension Office and if in town, check with the City Clerk's Office.

CHECK YOUR PROPERTY LINES. The first step in planning any fence is to check your property survey. In rural areas, adjoining fences are generally built on the property line with each owner paying half the cost. Within city limits, fences must generally be entirely on your own property and you pay all the costs. Again, check your local laws.

TALK WITH YOUR NEIGHBORS. It is a good idea to talk over fencing plans with the neighbor whose property will be next to the fence. Your neighbors may have questions about the "Common Sense Fence".

A. Sketch a Map and Choose your End, Corner, Dip and Ridge Posts

Begin by drawing a map of your property including all major features such as: buildings, roads, fields, swamps, woods, hills, gullies, streams and other features that might require special consideration during construction. Be sure to include: power and telephone lines, gas and oil pipelines and underground cables.

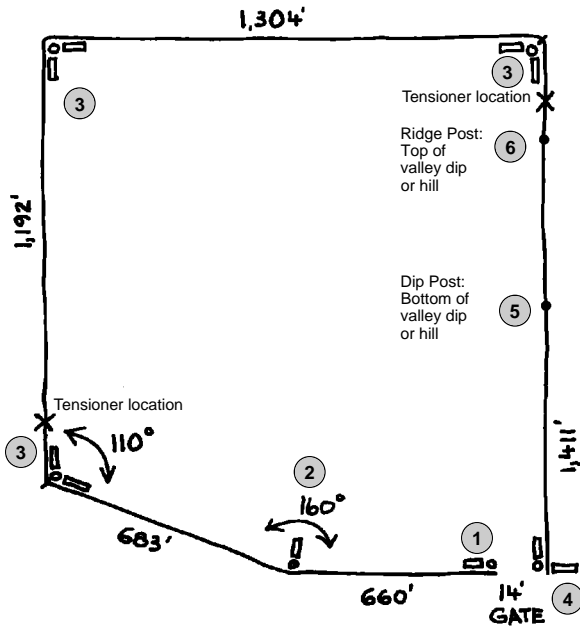

STEP 1.

Screw in anchors.

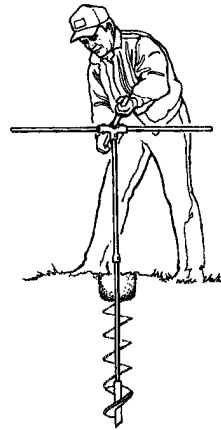

STEP 2.

Secure fiberglass corner posts and braces to anchors.



4, 5 & 6 FOOT HIGH MULE

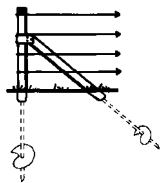

End Post - 1 Post, 1 brace and 2 augers to be used in two situations:

1. Where the fence will end and a gate will not be hung on that post.

2. For slight changes in wire direction and where a full corner is not required. Generally less than 60° and more than 120°.

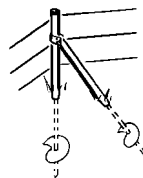

Corner and Gate Posts - 1 Post, 2 Braces and 3 Augers

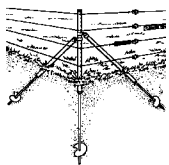

3. For all corners near 90° or

4. Where the fence will end and a gate will be hung on that post.

Note: Be sure to measure gate opening correctly to allow for gate hinges and latch.

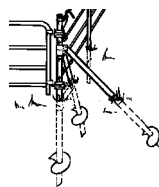

DIP AND RIDGE POSTS

5. Dip Post

To be used where the ground rises causing a lot of upward pull on the post. Use at the bottom of a valley dip or hill.

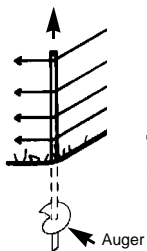

6. Ridge Post

To be used where the ground slopes down and tension on the wires will want to force the post into the ground. Use at the top of a valley dip or hill.

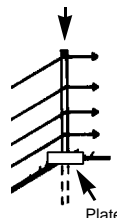

3 FOOT HIGH MULE

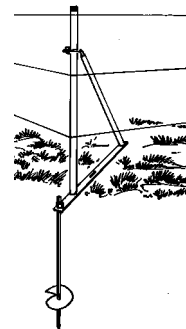

Single brace can be used as an end or a corner.

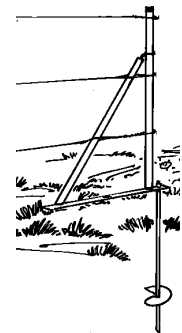

Install tool is built into bottom metal strap.

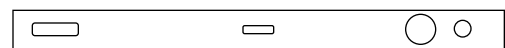

Double brace can be used for all ends and corners.

When pulling sideways on a gate post, you may prefer to use the double brace for more side stability.

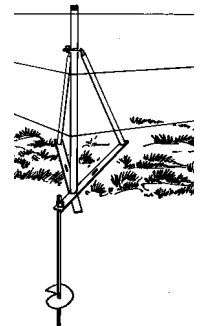

ANCHOR OPTIONS:

The 6" x 36" auger anchor is the standard and works in over 80 percent of the situations. However, for very hard, rocky ground, we have the 4" x 24" auger and for soft, deep sand, peat and swampy soils we have the 10" x 36" auger. In addition, 12" and 24" extensions are available to handle unexpected conditions that may require deeper penetration into the ground. We have not uncovered conditions to date that one of our Mule™ anchors can't handle. If one has solid rock, one can drill a 1¼" hole in the rock, insert the ¾" x 12"

extension, add grout, let it harden and install the corner system.



B. Wire, Tensioners and Crimp Sleeves

12½ gauge, 200,000 min. psi, high tensile, class III galvanized steel wire should be used. Its strength and elasticity will assure you of a fence that lasts for years. Care must be taken when uncoiling high tensile wire as it acts like a coiled spring and can easily become entangled. A "spinning jenny", as shown in the photo should be used to hold the wire in place as it's being uncoiled. Install in-line wire tensioners and secure wire as shown in illustrations below. Secure just ONE wire prior to driving line posts in. This should be the second wire up from the ground. Tighten wire with in-line wire tensioners so it stays straight and provides a guide for installing the line posts.



CRIMP SLEEVES

It is recommended that all wire connections be made using crimp splice sleeves and the special crimp tool. Use of the crimp sleeves will result in a splice equal to the strength of the wire.

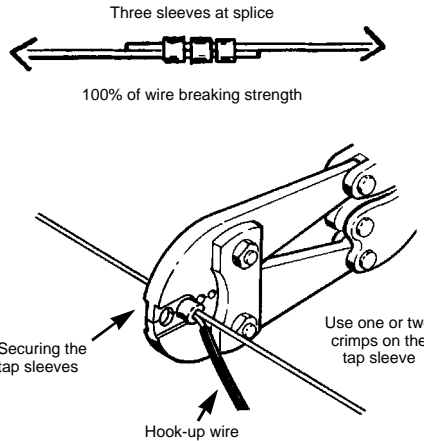
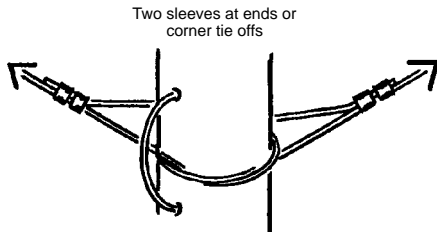

12½ gauge high tensile wire can be tied off as illustrated below. However, it is difficult to do and one does not achieve a splice strength equal to the strength of the wire.

SPLICE KNOTS

FIGURE EIGHT

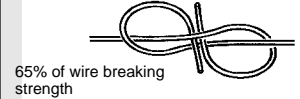

DOUBLE LOOP

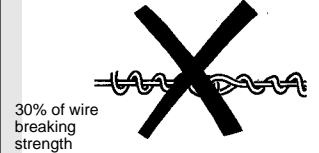

THREADED THROUGH

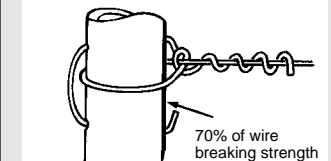

SIMPLE TWIST

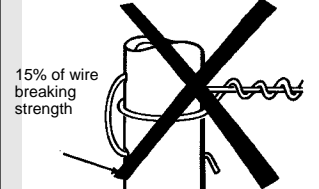

IN-LINE WIRE TENSIONER

(X) shows location of wire tensioner	Maximum feet of wire per wire tensioner
STRAIGHT LINE 	5,000 ft. max. Additional wire tensioners per wire are required if braced ends are over 5,000 ft. apart.
ONE CORNER 	5,000 ft. max. each Use two wire tensioners for angles less than 45° (one on each straight line)
TWO CORNERS 	3,000 ft. max. You can pull around one corner in each direction.

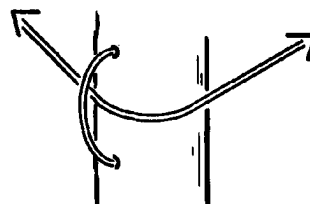

NOTE: Fence line wires may "flow" around corners allowing longer runs and the use of fewer tensioners. See chart.

(X) WIRE TENSIONER

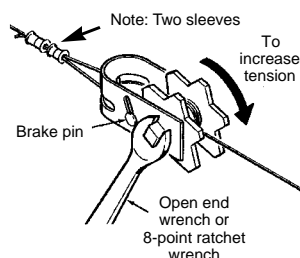

C. Drive in Line Posts and Install Clips

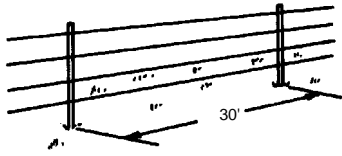

Suggested spacing for line posts is 30 feet.

See pages 6 and 7 for suggested wire spacing.

SECURE WIRE TO POSTS

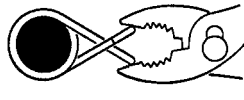

Squeeze hooks together. Slip clip onto post with longer hook down, release.

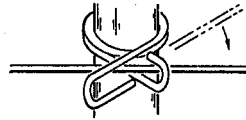

Pull wire up into bottom hook – rotate wire up and around until it is inside the upper hook. Release.

WIRE U-CLIPS

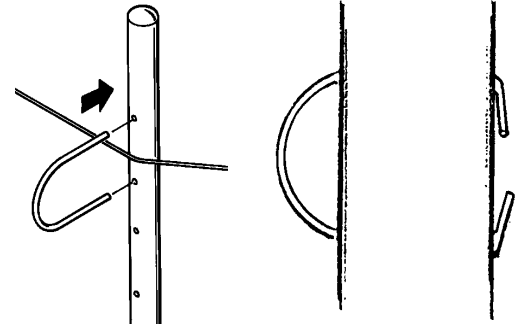

Push u-clip through two holes and use hammer for 2" posts to bend wires and pliers for other posts.

D. Tension Indicator Spring

Recommended wire tension is between 100 and 150 pounds for 12½ gauge wire. The springs are marked to show load. Generally, the wires need to be tightened so they do not have excessive sag and thus not likely to touch the wire above or below. Remember, ***ITS THE ELECTRICITY THAT IS CONTROLLING THE ANIMALS***, not the wire tension.

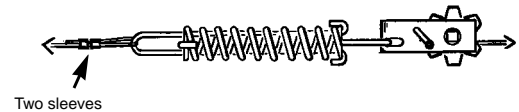

Gates

POLYETHYLENE TUBING

The "Common Sense Fence"™ System uses insulated hook-up wire inserted through polyethylene tubing to conduct fence line current underground. Polyethylene tubing provides additional insulation from the soil as well as protecting the insulation from the soil as well as protecting the insulation on the wires. The use of overhead wires is not recommended. Transfer wires that run overhead (conventional electric fencing) from controllers to fence lines and across gateways, are "high targets" for lightning strikes or may be damaged by farm equipment.

Underground use of insulated hook-up wire requires proper installation:

- Never have spliced insulated hook-up wires inside the polyethylene tubing.
- The ends of the polyethylene tubing must be made water resistant.
- Maximum distance recommended for underground wires is 200 feet. For longer distances, run a fence above the ground or install the controller closer to the fence. Spliced joints in the polyethylene tubing are not recommended.

WATER RESISTANT END FOR POLYETHYLENE TUBING

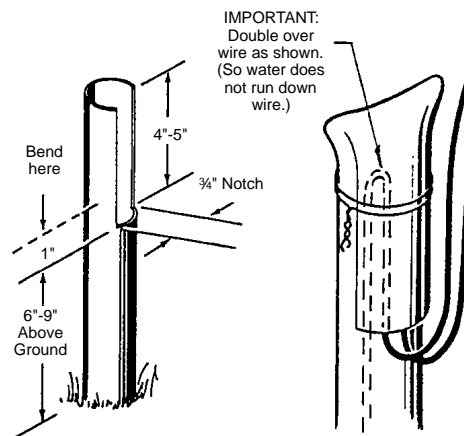

GATE BRACKET AND GATE HOOK PIN

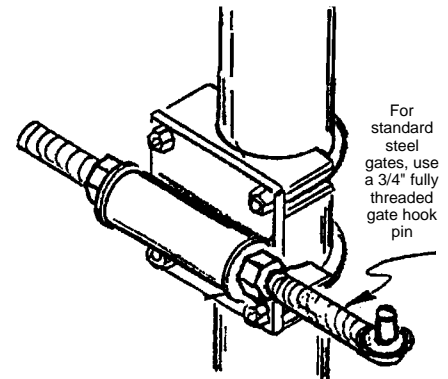

GATE LATCH BRACKET

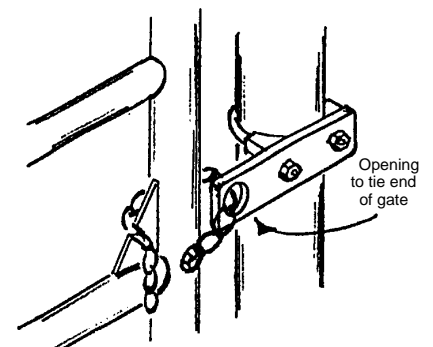

E. Fence Controller and Ground System

ALL HOT SYSTEM

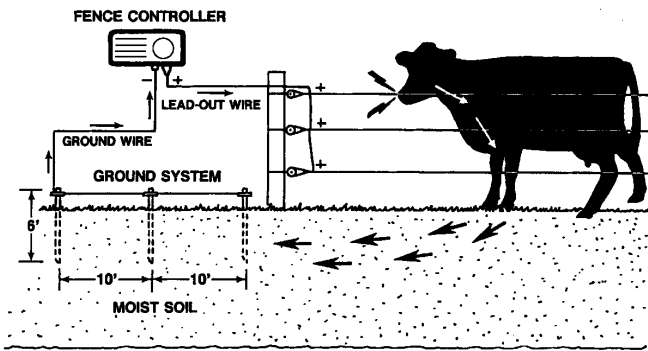

In an all hot system, the animal receives a shock by touching a hot wire which transfers the electrical charge through the animal, through the earth to the ground rods and back to the controller which completes the circuit. **This system relies on good ground rods and moist, unfrozen earth conditions.**

HOT/GROUND SYSTEM

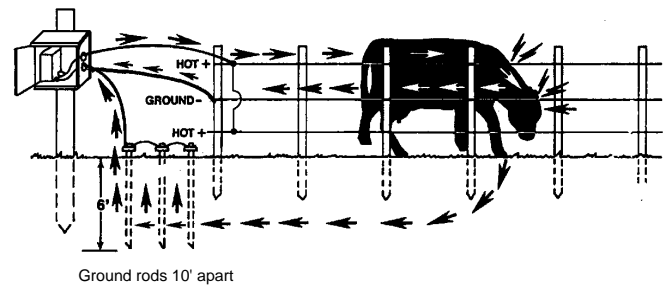

In the hot/ground system, the animal can receive a shock the same as the All Hot System and also by touching a hot (+) and ground (-) wire at the same time to complete the circuit. **For best results in all soil conditions, use a hot/ground system.**

DO NOT install ground rods within 50 feet of a utility ground rod, buried telephone line, or buried water-line (they may pick up stray voltage).

WARNINGS

SAFETY: Although modern fence controllers approved by recognized safety standard organizations pose no direct safety concern, indirect accidents can happen so it's important to be aware of the following WARNINGS before constructing your fence.

- WARN ALL PERSONS, ESPECIALLY CHILDREN, ABOUT YOUR ELECTRIC FENCE AND SHOW THEM HOW TO DISCONNECT THE CONTROLLER IN CASE OF EMERGENCY. If you permit hunters or other visitors to use your land, be sure they have been warned and that all of your electric fences are marked.
- USE AMPLE WARNING SIGNS. This is especially true around buildings or locations where you expect people to be. Warning signs should be used every 300 feet or less. In some states warning signs are required by law.
- ONLY USE CONTROLLERS WHICH HAVE BEEN APPROVED BY NATIONALLY KNOWN AND RECOGNIZED SAFETY STANDARD ORGANIZATIONS.
- BEFORE THUNDER OR ELECTRICAL STORMS, IT IS BEST TO DISCONNECT A CONTROLLER FROM THE FENCE WIRES AND REMOVE THE PLUG FROM THE LINE OUTLET.
- DO NOT FENCE DURING ELECTRICAL STORMS.
- NEVER GRASP A SUSPECTED LIVE FENCE WIRE.
- DO NOT TAMPER WITH OR ATTEMPT TO REPAIR CONTROLLERS. Controllers must be sent back to the factory or an authorized service shop for repairs.
- DO NOT USE MORE THAN ONE CONTROLLER FOR THE SAME SECTION OF FENCE.
- ALWAYS DISCONNECT THE CONTROLLER BEFORE HANDLING FENCE WIRES.
- WHEN WORKING NEAR OR TESTING ELECTRIC FENCES, KEEP FEET AND HANDS DRY.



- DO NOT USE BARBED WIRE WITH ELECTRIC FENCING.
- DO NOT STRING ELECTRIC FENCE WIRES OVER OR CLOSE TO WATER TANKS OR ANY WATER THAT MIGHT BE USED FOR SWIMMING.
- DO NOT ERECT AN ELECTRIC FENCE UNDER OR NEAR OVERHEAD POWER LINES. Because electric fence lines are well insulated from the ground, fallen power lines can send lethal amounts of electrical power for much greater distances than can non-electric fences. Check with your local power authority so see if this is a potential problem. The following illustration shows one method of safely passing under a power line with an electric fence.
- BE SURE THAT YOUR ELECTRIC FENCE WIRES (both wire return and hot) DO NOT COME IN CONTACT WITH YOUR BUILDING.
- NEVER USE YOUR POWER LINE GROUND RODS OR YOUR PLUMBING SYSTEM AS A GROUND FOR YOUR ELECTRIC FENCE.
- KEEP GROUND RODS FOR THE ELECTRIC FENCE AT LEAST 20 FEET AWAY FROM ANY:
 - Utility company rods.
 - Telephone company ground rods.
 - Underground metal pipes
 - Metal supports for structures which lie upon, or have been driven into, the earth.

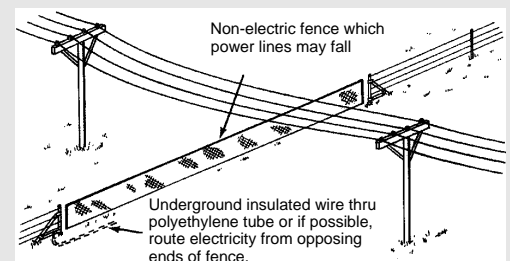

Suggested Wire Spacings:

The designs shown are for general reference and may be modified for your own specific containment needs.

3 Foot High MULE

HORSES, CATTLE

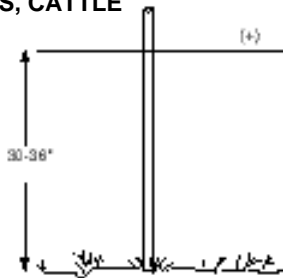

Figure 1

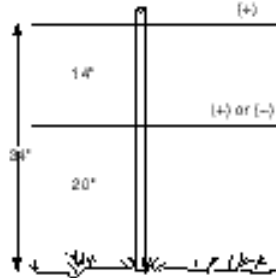

Figure 2

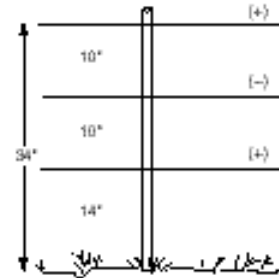

Figure 3

SHEEP, GOATS, HOGS

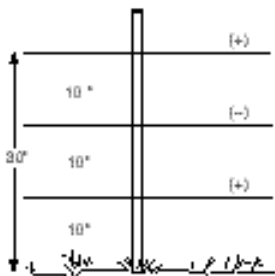

Figure 4

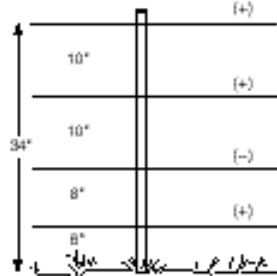

Figure 5

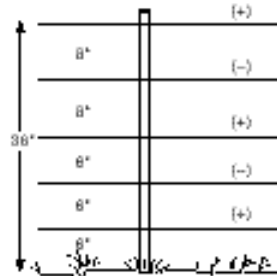

Figure 6

RABBITS, RACCOONS

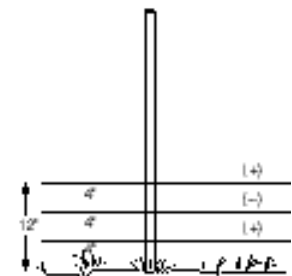

Figure 7

4 Foot High Heavy Duty MULE

HORSES, BEEF, DAIRY

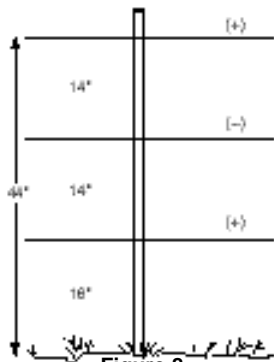

Figure 8

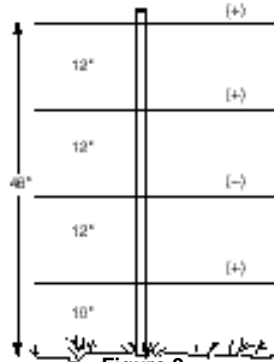

Figure 9

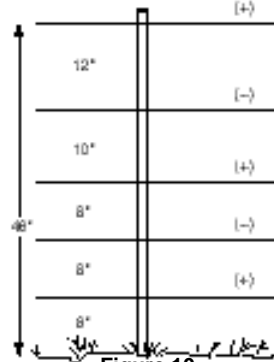

Figure 10

SHEEP, GOATS, HOGS

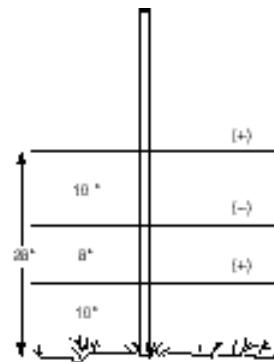

Figure 11

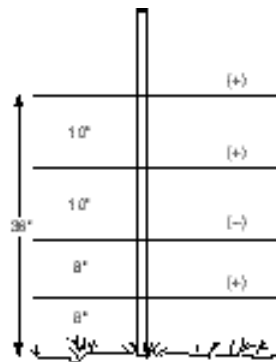

Figure 12

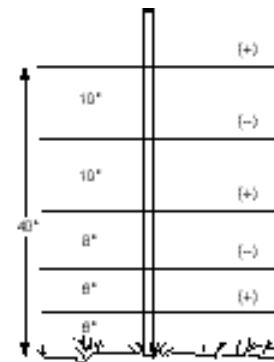

Figure 13

5 Foot High Heavy Duty MULE

BUFFALO, DEER, DAIRY, HORSES, BEEF, PREDATORS, LLAMA

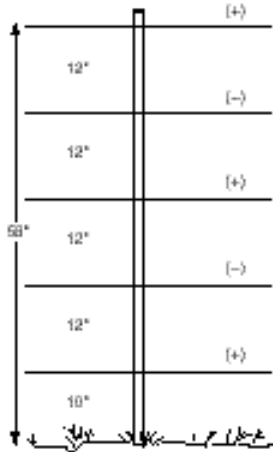

Figure 14

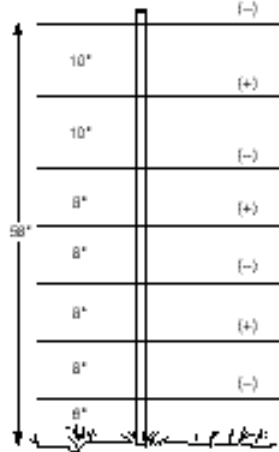

Figure 15

PREDATOR CONTROL – COYOTES, DOGS, WOLVES, ETC.

Fencing requirements are generally greater for the control of wild animals. This is because of their more aggressive behavior towards fences and barriers. Just as with livestock, it is important to consider the physical and behavioral characteristics of the wild animals which you are going to control. Dogs and their relatives are of particular interest because they have no sweat glands. This greatly reduces the moisture on their skins, making electrical flow more difficult and thus a less effective shock. A fence for these predators must be high enough to keep them from jumping over, wire spacing close enough to keep them from squeezing through. The 9-wire general-purpose predator fence shown in Figure 17 forces the predator to climb the fence. This insures simultaneous contact by two or more of its padded paws between the (+) hot and the (-) wire return producing the most effective shock to control these predators.

6 Foot High Heavy Duty MULE

BUFFALO, DEER, PREDATORS, BEAR

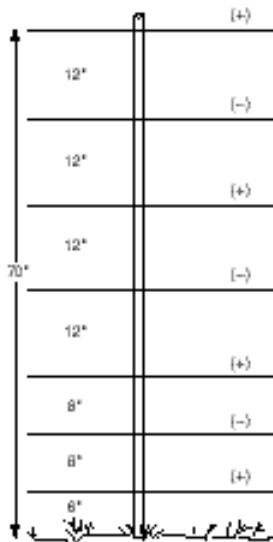

Figure 16

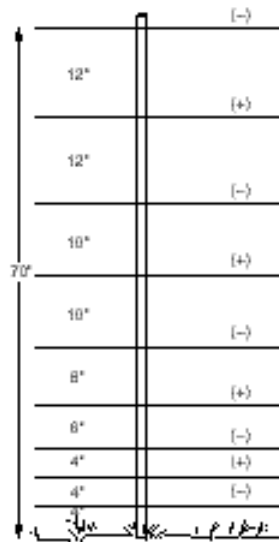

Figure 17

4 Foot High Electric Rail MULE

1 1/4" RAIL, 2" POST



Figure 18

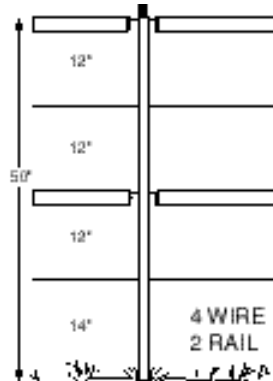

Figure 19

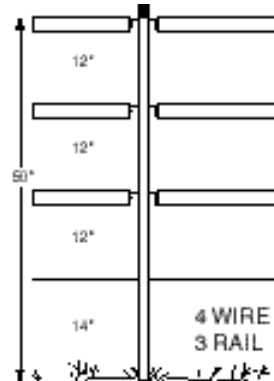

Figure 20

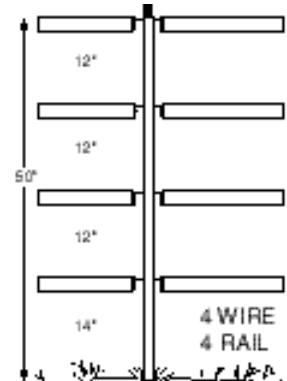

Figure 21

